



January 2008

# DECISION '08

VOTE

YES	<input checked="" type="checkbox"/>
NO	<input type="checkbox"/>

FOR

# CAMP FOLEY IN 2008!

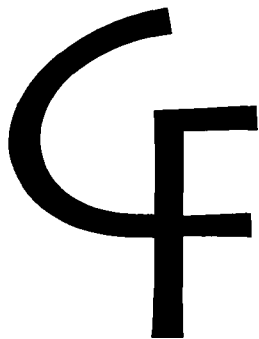

Over **370 kids** have already decided to make Foley part of their **summer in 2008!** If you are not one of them, forget about the presidential elections, make the most important decision of your year - **Foley in 2008!**

We hope your **New Year's** was stellar and that you have a fantastic 2008!

Make Your Summer SIZZLE!

# Camp Store!

The Online Camp Store is awaiting your orders! We have lots of sweatshirts and t-shirts that would make great presents for family and friends.

Also, due to the popular demand of the sweatpants last summer, we have reordered and now have those available in **red and grey** and in **all sizes** (both youth and adult). These are great for all those winter sports and activities as well as lounging around the house!

Get "Foley Geared" up!

[www.campfoley.com](http://www.campfoley.com) - For all your shopping needs!



NEW Sweatpants!

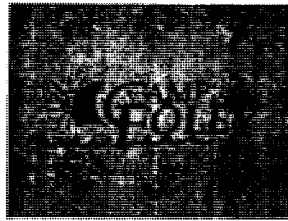

Beach Towels



Hoodies!

## 2007 Fun Facts

In 2007...

...we had representatives of:

35 States

8 Foreign Countries: Mexico, Italy, France, Sweden, New Zealand, Ireland, Japan, & England

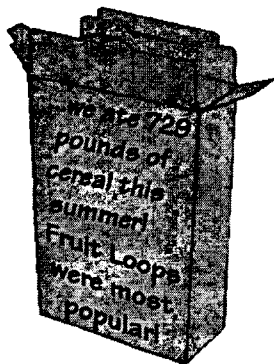

...we ate 180 pounds of marshmallows...



...and 3069 Graham Crackers!

## Wedding News!

We would like to congratulate long time counselors Mike Mogard and Kate Fuller on their engagement!

Kate first joined us in 2001 as a cabin counselor. She has been here every summer since, even staying around for a winter one year as well. She now works as an Assistant Director during the summer, concentrating mostly on the foxes (plus all the random stuff at camp).

Mike first came to Foley in 2003 to work with our youngest boys and to teach archery! His leadership has helped keep all the kids happy and healthy. He is often seen up at the archery range challenging the campers to contests or driving the lawn tractor around camp with his cowboy hat on!



The wedding will be this spring with some or all of the festivities happening either at camp or in the area around camp! We are very excited for both of them and wish them the best in their life together!

You can send congratulatory emails to:

Kate Fuller - [katecfuller@hotmail.com](mailto:katecfuller@hotmail.com)

Mike Mogard - [mm3\\_11@hotmail.com](mailto:mm3_11@hotmail.com)



# Meetings and Video Showings

## A New Era

One of the biggest reasons that Foley is as successful as it is today is because of the tireless amount of energy our camp families put in to promoting camp to other families! We would not be the organization we are today, or have the world wide spread of campers and staff, without the help of all our camp families. Word of mouth is still our #1 advertising mechanism and for this we need to say **Thank You** to each and every one of you!

Likewise we have always truly enjoyed the time spent in your communities and homes reminiscing about camp memories and exposing new parents and kids to what Foley has to offer.

It is with much debate (and in some cases heavy hearts) that we are changing up how we do some of our community meetings this year. Our hope is to better accommodate the busier schedules of our camp families and tailor the gatherings to the needs and wants of those that are attending.

## Twin Cities Area

Tuesday, January 22nd at 7:00 pm - Southdale Area Library, Ethel Barry Room, 7001 York Ave. South, Edina  
February - There will also be a meeting in the area sometime in late February or early March.

## Chicago Area

Wednesday, January 23rd or Thursday January, 24th - A gathering will be planned for one or both of these nights.

## St. Louis Area

Saturday, January 26th - We will be at the Camp Fair at MICDS on Saturday, January 26th, 10am to 3pm  
A gathering will be planned for Sunday, January 27th or Monday, January 28th.

## Phoenix Area

Saturday, February 23rd - We will be at the Camp Fair at All Saints Episcopal Church & Day School, 10am to 3pm  
A gathering will be planned for Sunday, February 24th or Monday, February 25th.

## Don't See Your City?

If you don't see your city listed below - never fear! For some of our smaller areas of kids we thought it would be better if you let us know what works for you! We are more than willing to send a Foley representative to your area! We can have a pizza party or find an activity to do you in your area! We can also do an in house meeting with interested families!

It is getting harder and harder for us to pick dates that work for you, so let us know! **Talk to your friends, family, neighbors or school mates and give us a few dates that might work!** We can meet with new campers or come and hang out with past camper families!

We truly want to see each and every one of you and are trying to figure out the best way to make that happen!

**Watch the mail and the website for more information on all of these gatherings and more that may be scheduled!**

## Session Availability!

All sessions have space available for **boys and girls** of all ages unless otherwise indicated. Grades correspond to grades for NEXT school year. **Please check the website regularly as things change quickly!**

### Four Week Sessions (Coed ages 8 to 16)

Tuesday, June 17 - Monday, July 14

Wednesday, July 16 - Tuesday, August 12 Waitlists started Boys 8th-11th grade and Girls 6th-11th grade.

### 2 Week Sessions (Coed ages 8 to 16)

Tuesday, June 17 - Monday, June 30

Tuesday, July 1 - Monday, July 14

Wednesday, July 16 - Tuesday, July 29 Boys: Full 8th-11th grade; Limited 2nd-7th. Girls: Full 6th-11th grade; Limited 2nd-5th.

Wednesday, July 30 - Tuesday, August 12 Boys: Full 8th-11th grade; Limited 2nd-7th. Girls: Very Limited 8th-11th grade.

### 1 Week Sessions (Coed ages 8 to 11)

Tuesday, June 17 - Monday, June 23

Tuesday, June 24 - Monday, June 30

### Introduction to Camping (Coed ages 8 to 12)

Wednesday, August 13 - Sunday, August 17

### Is your session filling up??

As sessions begin to fill, it is important to contact us as soon as you know what session you want so we can get you on a waitlist and/or let you know what your options are!



# What's Great for 2008!

## Final Banquets!

**Sessions 1 & 3 - June 17-30 & July 16-29:**

Get ready for a **Foley Fiesta!** In honor of all our campers from Mexico we are throwing the Foley version of a true Mexican Fiesta! Pinatas, maracas and sombreros! Come show spirit for our neighbors to the south. Dress either in traditional gear (ponchos, sombreros) or the colors of the Mexican Flag - Red, Green and White! The day will be spent playing popular games from Mexico and learning all about their culture!



**Sessions 2 & 4 - July 1-14 & July 30-August 12:**

**Summertime Thanksgiving!** Although the traditional American holiday is usually celebrated in November we thought it would be fun to put a summertime twist on it. Will you help create a re-enactment of the first Thanksgiving? Perhaps join in the Foley Thanksgiving Day Parade? Or is football more your thing? The possibilities are endless! Dress in traditional Thanksgiving gear or come as your favorite balloon from the Thanksgiving day parade! You can even dress as your favorite Thanksgiving food, football team or wear your favorite Turkey adorned sweater!

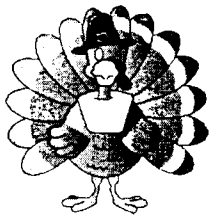

as your favorite Thanksgiving food, football team or wear your favorite Turkey adorned sweater!

## Grand Dance Festival!

We have listened to your suggestions and this year we have once again decided to make the theme of the Grand Dance Festival known to you all before you come to camp! As with other years, the dance festival has a little bit of everything. Tennis, volleyball, human foosball, pool, ping-pong and of course - Dancing!

We have decided on a theme of "Nerds"! Of course in keeping with our goal of having you all be involved in everything at camp, this theme came from many of the surveys and conversations from last summer! **Find some suspenders, hats with spinners on the top, tall socks, etc. Layer your clothes or wear lots of different colors!**

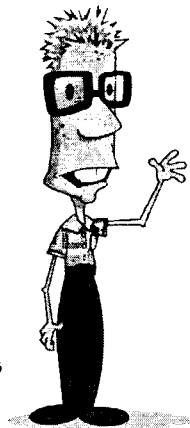

## Camp Clubs

Last summer the "Running Club" at camp took off and had 20 members or more by the end of 4th session, so we thought it would be fun to think of some other clubs that campers and staff may want to be a part of! Being part of a club can be fun and mysterious! Have you always wanted to try Yoga? Or learn how to tie a fly for fly fishing? Learn how to play croquet? Or perhaps create some of the segments for the Foley Podcast, "The Gong"? This is your chance! A couple times throughout the session you will have the opportunity to spend time with a club of your choice and learn all about a special skill or interest that you have! We will be calling on all of our wonderful staff to share their talents with you and if you have any ideas let us know!



## Come On Down!

The Price is Right! Deal or No Deal! Jeopardy! The Family Feud! Double Dare! Game shows are everywhere! This summer at Foley we will have our own versions of classic game shows as well as some of the newer ones on T.V. Try your hand at **guessing prices** of random things around camp. Answer **history** questions about Foley. Challenge your friends to **physical and mental challenges**. There will be a little of something for everyone! You never know you may even walk away the **Grand Master Champion....**



## 4th of July!

It has been 3 years since we have had a full session going on over the 4th of July and we are excited to get the celebration going again! We are going to be mixing some of the **old classic Foley stuff** (costume contests, skits and of course singing all of those great American classics like Yankee Doodle) with some **new ideas**. Perhaps we will do some debating? Or make campaign buttons for ourselves? **Who said we can't run this country!?** Whatever we decide to do, be sure to bring your red, white and blue and be ready to celebrate our Independence in style!



# Wolf Campers (13 and up)!

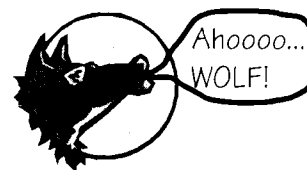

## Leadership Program!

Yes, camp is still a long ways off, but we already have campers registered and thinking about Foley for next summer. Likewise, the **new LIT and CIT** info is up on the website and we have already had kids letting us know of their interest. Space is going to be more limited this year so getting



your applications in early is going to benefit you greatly. If you are going to be a **9th, 10th or 11th** grader next fall and are a returning camper, you are eligible! **Check out the website for the forms or email Alli (alli@campfoley.com) for more information!**

**Check out the website for the forms or email Alli (alli@campfoley.com) for more information!**

The following campers have already made the commitment to be part of this great program: Will B, Jessica H, Char C, Tali D, Rosie Mc, Sarah H, Emilia K, Antonio C, Courtney K, Matt K and Erik M.

Come build your skills for the future!

## Dishwashing Squad '08!

Do you have what it takes to be a **Foley dishwasher**? Are you **14 and older**? Those of you, who have been coming to Foley for a while, know how important the job of Dishwasher is. It requires an **excellent attitude**, the ability to **learn new skills**, and the **desire to work as a member of a team**. As a dishwasher you get to work behind the scenes at Foley to ensure that all the dishes are cleaned and ready for the next meal. This position will help develop your leadership and service skills and provide you with the work experience you need to land that first Job!



**Already registered for camp?** Great! Download the forms from our website or email us (fun@campfoley.com).

**Not registered yet?** What are you waiting for? Fill out the Dishwasher Application and send it in with your registration today!

As an added bonus you can help your parents pay for camp! \$60 for 6 times or \$120 for 12 times! **Join Now!**

## Backpack Trip!

Do you want 3 days out in the wilderness with a bunch of friends and 2 great staff? Do you want to hike part of the **Lake Superior Hiking Trail** (rated as one of the top 10 trails in the country!)? Feel like challenging yourself or putting a new twist on your summer? This trip is for you!

In order to make sure you have the best trip possible you **must** sign up for this trip before camp - **if we don't get enough - NO TRIP!** Talk to your friends!

Email or call if you are interested! You can find more information on our website! Let's keep the tradition going!

## Wanted:

- Old lap top computers that can run Microsoft Word - used by counselors in writing letters to parents about their campers.
- Old candles for Crafts program

## Foley's Podcast - "The Gong"!

Many of you have already gotten hooked on "The Gong" - Foley's Podcast! If you have yet to discover the magic - you should! Each month a new one will be posted! Catch up with **news** from around camp, learn how all **your friends are doing with their sports and activities** as well as find out who has **birthdays** and be entertained by various **stories and facts!** We also do interviews and allow you to give input on what is on the next episode.

Want to learn more?? Check out the website and click on the "Podcast" link. You can subscribe (don't worry - it's FREE) to "The Gong" also! This ensures you don't miss an episode!

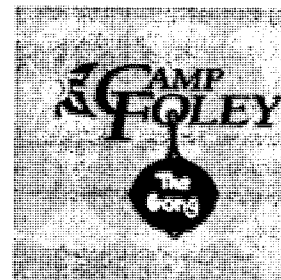

We want your input as much as possible! **Email, call, facebook, or write us a letter to give us updates on what you are up to** throughout the winter so we can add you to the next broadcast!



# Look Who's Registered! (as of December 6th)

**A** Quinn Abrams, Lucas Absolon, Effie Albitz, Jackson Amodeo **B** Henry Bacon, Olivia Bacon, Laura Baker, Paul Barnes, Chris Beeth, Emily Beh, Megan Beh, Kevin Beltz, Kylie Beltz, Gaston Benitez, Vince Biaggio, McKenna Bolger, Grace Boyd, Madeline Boyd, Nicole Boyd, Andrew Bradley, Elizabeth Brown, James Brown, Jessie Brown, Julia Brown, Marnie Brown, Vic Bruene, Sutton Bryan, Blaise Bucey, Dwyer Bucey, Dane Buchman, Blitzzen, Jonathan Buchman, Alice Buren, Daniel Burford, William Burke **C** Nick Cadle, Reed Caldwell, Antonio Camiro, Maria Elena Camiro, Andres Campbell, Sydney Carlson, Charlotte Carlton, Olivia Carlton, Matthew Carney, Claire Castaneda, William Chmielewski, Catherine Cole, John Combs, Comet, Rachel Conley, Michelle Conway, Anna Copman, Samuel Copman, Jacob Courtney, Cupid **D** Alex Davis, Stephen Davis, Dancer, Caroline Degnan, Abby Deutz, Ivonne Dieck, Jorge Dieck, Mick Donahue, Carter Downs, Emily Draper, Dasher, Stefanie Draper, Alex Driessen, Tali Driessen, Abby Dryer, Walter Duff, Alexandra Dulles, Mimi Dwan, Elizabeth Dwyer, Joe Dwyer **E** Connor Eastman, Jessica Eastman, Ethan Eiler, Annie Epstein, William Erickson **F** Conor Failor, Jack Failor, Jordan Fallon, Kaitlin Faoro, Gaby Feltner, Melissa Ferrie, Regan Fiascone, Joe FitzPatrick, Meggie Flinn, Jack Foley, Sam Folkman, Danny Foussard, Katie Freeman, Helen Friberg, Maria Frogelius **G** Nicholas Gabanski, Nick Gaither, Andrew Gallagher, Rachel Gans, Daniel Garcia, Jorge Garcia, Madison Gartner, Marlee Gartner, Courtney Geller, Alexander Gerrard, Grace Gerrard, Elizabeth Gesensway, Julia Gesensway, Gus Glab, Toby Glover, Julia Goldman, Nicholas Goldman, Alejandra GomezJunco, Michael Guckeen, Tyler Guckeen, Gaspard Guerand, Mauricio Guerrero, Geena Gunter, Joe Gunter, Charlie Gusho, Lucy Gworek, Yanna Gworek **H** Charlie Haakenson, Archie Hamel, Jack Hamel, Susie Hamman, Kevin Hannigan, John Harper, Lauren Harper, Brittany Harrington, Paige Harrington, Collin Harris, Maddie Harris, John Hartfiel, Madeleine Hartmann, Anna Heinemann, Jessica Hickok, Isabeau Hill, Mark Hill, Mia Hill, Emily Hines, Sarah Hines, Casey Hinken, Jake Hoehne, Justin Hoehne, Danny Holmes, Hannah Honeycutt, John Horan, Claire Howes, Jessica Howes, Casey Hudak, Madeline Hudak, Greg Huey, Peter Hughes, Sarah Huss, Gracia Hutson **I** Audrey Imbs, Cole Imbs, Mac Irvine, Tyler Isaacs, Christopher Ivins, Lauren Ivins, Victoria Ivins **J** Cameron Jackson, Abigail Johnson, Avery Johnson, Ian Johnson, Josephine Johnson, Kallen Johnson, Lars Johnson **K** Sarah Karels, Henry Kauth, Kathleen Kenny, Bailey Keogh, Hannah Keogh, Taylor Kiffin, William Krebsbach, Courtney Kronschnabel, Emilia Kronschnabel, Matt Kronschnabel, Nick Kronschnabel, Tory Kronschnabel, Sara Krueplestaedter, Logan Kugler, Helen Kuhn, Jack Kunkel, Lauren Kunkel **L** Lindsey Lande, Alex Leever, Claudia Leon de la Vega, Miranda Lockner, Isabella Loosbrock, Madeleine Loosbrock, Travis Louhi **M** Natalie MacIntosh, Turner MacIntosh, Colleen Mahoney, Ellie Mahoney, TJ Mahoney, Jose Maiz, Claire Mancheski, Eleanor Mancheski, Peter Markee, Carlos Martinez, Michael Mathis, Lilly McCarty, Rosie McCarty, Zachary McCormick, Emily McGuire, Katie McGuire, Megan McGuire, Molly McGuire, Shannon McGuire, Lindsay McKerr, Tessa McKerr, Lucy Melbinger, Alex Meneses, William Merriam, Matthew Meshbesh, Caroline Michalek, Cole Michalek, Hannah Michalek, Alex Miley, Ryan Miley, Lisa Miller, Kevin Moakley, Sean Moakley, Hannah Moen, Bridget Moffet, Caroline Moore, Robert Moore, Roman Moore, Jesus Moreno, Alex Moskowitz, Chase Mueller, Erik Mueller, Jack Munkeby, Joe Munkeby, Mae Munkeby, Sam Munkeby **N** Bailey Ness, Addie Newsome, Marjorie Newsome, Connor Nickelson, Alexandra Niebur, Braze Nolin, Chase Nordstrom **O** Callan O'Connor, Walt O'Connor, Analise Ober, Evan Oncay, Grant Oncay, Andres Ornelas, Rodrigo Ornelas, Diego Orta, Gerardo Orta, Juan Pablo Orta, Lars Oslund **P** Julia Parkerson, Evan Patchen, Kaeli Patchen, Katie Patrick, Ryan Patrick, Jack Pawlik, Michelle Pazin, Calvin Perkins, Jeff Pflanz, Prancer, Parker Poche, Eliot Pulling **Q** Gabriela Quintero **R** Jessica Reinhart, Christopher Revord, Claire Revord, Jack Revord, Michael Revord, Will Reynolds, Alejandra Rios, Patricia Rios, Calvin Rose, Guillermo Rumbaut, Sammy Russell, Rudolph, Michael Rutzick, Alex Ryan, Chase Ryan, Emma Ryan, Jackson Ryan, Karli Ryan **S** Rick Schader, Emma Schaffer, Leah Schaffer, Charlie Scheitlin, Thomas Schelble, Eric Schmid, Megan Schmidt, Spencer Schramm, Caroline Schuler, Mary Grace Schuler, Jonah Schwartz, Emily Sciortino, Mary Claire Seeberg, Jack Selzler, Rose Shaffer, Abbie Sharpe, Emma Sharpe, Elizabeth Shaw, Olivia Sieff, Ben Sigel, Ellie Sigel, Danielle Sikora, Alyson Sklare, Sam Sonnier, Olivia Spellmire, Cole Spencer, Eden Spencer, Tate Spencer, Cole St. John, Nicholas St. John, Ryan St. John, Coleman Stephenson, Hannah Stevens, Jill Stevens, Clare Stoddart, John Stone, Thomas Stone, Daniel Suchsland, Philip Swanson **T** Jack Taylor, Liesl Thome, Jack Thompson, Bridget Thomson, Katie Traub, Juan Pablo Trevino **V** Alejandra Villarreal, Eugenio Villarreal, Vixen, Hedvig Von Essen, Oscar Von Essen **W** Emily Wack, Charlie Walden, Jack Walden, Luke Walden, Jay Wallace, Jack Walsh, Rachel Walter, Grant Weis, Hunter Weis, Jack Welch, Robbie Welch, Rachel Westra, Steven Westra, Anne Wheeler, Joseph Wheeler, CJ Whitaker, Drew Whitaker, Grant Whitaker, Kendall Williamson, Anderson Winslow, Katie Winslow, Jordan Winter, Austin Wolfe, Lizzy Wolfe, Vivian Wolkoff, Connor Wright, Margot Wright, Spencer Wright **Z** Joe Zirnheld, Maggie Zirnheld, Alex Zwaschka

## Faces in the Office



Marie Schmid  
Director



Jeff Beltz  
Director



Mary Hicks  
Office Administrator  
Registrar



Alli Faricy  
Assistant Director



Luke Schiller  
Assistant Director



# 2007 Scholarship Donors

We would like to extend a big THANK YOU to everyone who supports this program through contributions. Although our 2007 Scholarship Donations, totaling \$7244.09, fell short of our goal of \$8500.00, we were still able to offer full or partial scholarships to 19 deserving applicants.

Our scholarship campers add diversity to our camp community, generally coming from inner city and rural settings. Some of them are wards of the state, being raised by a grandparent, from low income families struggling to make ends meet, or from needy families seeking opportunities to provide their kids with positive alternatives to inner city gangs, drugs, rural isolation and/or other challenges. Foley is committed, as are you, to providing positive camping experiences that aid to build an individual's self-esteem and skills, and build relationships with persons who serve as positive role models in both peers and adults.

Our goal for 2008 donations is \$8000.00 (scholarship dollars plus canteen balance to scholarship program). We are hoping to see an increase in donations so we will be able to continue to offer the Foley experience to as many deserving applicants as possible. Thank you in advance for your continued support of this program!

Here is what a few of them had to say about their 2007 Camp Foley experience:

"Sarah was the best swimming coach ever. She helped me out a lot by teaching me new swimming skills. I am in swimming lessons right now improving the skills I learned at camp...I enjoyed you all and am looking forward to seeing you all next year." Girl, age 10

"Thank you for giving me the opportunity to come back to Camp Foley. Because of your generosity, I was able to have the summer opportunity of a lifetime...I was able to do some new things this year at camp including trap, windsurfing, skiing, and going into the weight room. I was finally able to do whatever water activity I wanted this year since I passed the swim test." Boy, age 13

"THANK YOU! I had a really great time at Camp Foley... Because of your genuine concern for me, I am looking forward to attending Camp Foley next year. I can't wait to climb the wall with Ben, play tennis with Amber, and take on Melanie in archery." Girl, age 9

## Want to make a donation???

Please send your tax deductible donation to Camp Foley. Checks should be made to the "American Camping Association" and designated for the Camp Foley Scholarship Program.

## Direct Scholarship Donors (\$6500.00)

Joseph and Kathleen Blanke  
 Tom Braig  
 Julia Brown  
 Mary Durkee Galbraith  
 Michael Goldberg  
 Greg Haley  
 Cynthia Harris in honor of her daughter Jennifer  
 Colleen and Henry Huey  
 John and Carol Keogh  
 Ted, Stacy, and TJ Kronschnabel  
 Richard and Kim Merriam  
 Rev. Tim Power  
 Gerald Reichert in memory of H.L. Reichert, M.D.  
 Kathy and John Sluis in honor of camper Michael Sluis  
 Dana and Holly Terndrup  
 John and Lois Welshons  
 E. Jane Williams  
 Haven and Linda Williams

## Family Donations via Summer 2006 Canteen Balances/Other (\$ 929.65)

Edward and Cheryl Adler	Larry and Beth Lenke
Carlo and Heidi Baravalle	Jim and Lynda Mader
Julie Brennan	Anthony and Marina Mannara
Scott and Kristen Brewer	Dana and Charlene Mayo
Wesley and Julie Clelland	Bill and Mary Nolin
Deborah Crawford	Mark and Anita O'Hara
Mark and Heather Dickinson	Mark and Bianna Pazin
Kimberly Dumas	Mark and Jacki Prokop
James and Kristi Eiler	Chris and Ann Pulling
Michael and Jill Fay	Patrick and Kelle Rolfes
Phillip and Jeanne Foussard	John and Jill Romans
Bernardo and Catalina Garza	Dan and Erica Schmiel
Michael Geller	David and Molly Sigel
David and Kathleen Gesensway	Richard and Yun-Ho Sikora
Matt and Nina Gworek	Shelia and Thad Spencer
Rick and Kate Hartfiel	Jim and Ann Tinsman
Joe and Jayna Heinemann	Thomas and Julie Turchi
Nancy Holt	Tom and Christine Walsh
John and Karol Keogh	John and Tracey Zabriskie
Paul and Deidre Kronschnabel	



Make your summer SIZZLE!

9303 Father Foley Drive  
Pine River, MN 56474

BULK RATE  
U.S. POSTAGE  
PAID  
PINE RIVER MN  
PERMIT NO. 72

Address Service Requested

**In This Issue**

- 2008 News
- '08 Special Programs
- '07 Scholarship Donors
- Look Who's Registered



Make your summer SIZZLE!

9303 Father Foley Drive  
Pine River, MN 56474

**Tell Your Friends About Foley!**

Do you know someone looking for fun, friendships and new skills? Share with them your memorable experiences of Camp Foley and encourage them to register. So... tell your friends and family!

**Send Information Immediately To:**

Last Name \_\_\_\_\_ Home Phone (\_\_\_\_\_) \_\_\_\_\_

Father's Name \_\_\_\_\_ Mother's Name \_\_\_\_\_

Address \_\_\_\_\_

Children's Names & Grades \_\_\_\_\_

\_\_\_\_\_

Referred by \_\_\_\_\_





# CAMP FOLEY

March 2008



**Refreshing Foley!  
What's New  
for 2008!**

## **NEW FunBugs!**

The red playaks are gone so we decided to get 4 new fun toys for the swimdock! FunBugs are a mix between a surf board and a boat that you stand on. The more you move them side to side the more you can move forward through the water. Races,

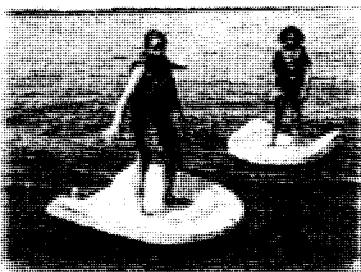

competitions in the waves and other fun games are already in the works! Get ready for some more crazy Paddlemania fun!

## **NEW Sailboats!**

After the wide success last summer of the Hunter JY-15 sailboats we are purchasing 2 more to complete our fleet of 6! Of course we will still have the Mangos and Catalinas as well. Campers last summer found the JY-15's to be faster to rig and faster on the water! We are excited to get some great races going and to get more kids out on the water sailing!

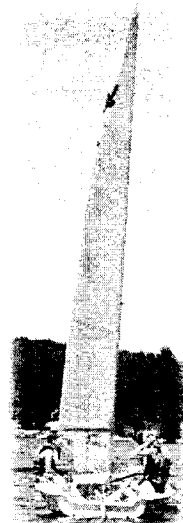

Make Your Summer SIZZLE!

# Partnering with Parents!

## The Promise

By Peg L. Smith, CEO of the American Camp Association

### This summer, promise your child . . .

New experiences, growth, fun, and caring. The special moments of childhood that provide those learning experiences come from many sources. The unique experience that is camp gives children all of those things — and more.

An opportunity to be independent and learn resiliency. Many parents have understandable worries and concerns about their children growing up in today's world. Those worries become counterproductive, though, when they get in the way of children's experiences in taking healthy risks. Camp offers the chance for them to take those risks in a structured, nurturing community of professionals who can guide children on a journey of self-awareness and self-reliance.

A memorable life experience that can increase self-confidence. At camp, children are exposed to new experiences that can create "aha!" moments. "I can do this!" "I'm good at this!" "I thought this would be hard, but it wasn't so bad." "I guess it's OK to try something new." Exploration and discovery are key elements of the camp experience.

A new perspective on his or her interests. Maybe your son or daughter has discovered a special interest in photography or the performing arts. There are camps to encourage those newly-found passions! Beyond traditional camp activities, camps offer

programs that address many interests, whether it's aviation, caves, or drawing and painting. The opportunity to explore these means of self-expression in a noncompetitive environment allows for natural development of curiosity and talent — and maybe even starts your child on a new academic or career path.

The chance to learn in the broader world outside of school or home. Not only does camp enhance campers' skills at activities such as sports, language, art, or science, it provides the chance to learn more about the world through new friendships, activities that promote cooperation, and challenges that foster decision-making abilities and leadership. "Mentor" time spent with caring adults, as found at camp, helps children learn new ways of being part of a wider social world.

Valuable time spent in nature. Whether it's a hike in the woods at day camp to identify trees or a wilderness trip bringing your child closer to nature than ever before, the immersion in the natural world not only teaches children how to appreciate the environment, but, as studies have shown, can be therapeutic in reducing the stress of everyday life and can even help improve academic performance.

**We look forward to helping fulfill that promise during the summer of 2008!**

## Foley's "The Gong" Podcast!

Many of you have made listening to the **Foley Podcast** part of your monthly routine! If you have yet to check it out - you should! From stories to facts about nature to announcements from our campers and staff, the podcast covers a wide variety of topics! It has been fun to share what is going on at camp and to keep some of the crazy Foley spirit alive during the winter. **Check out the podcast page on the website for more information: <http://www.campfoley.com/html/campers/podcast>.**

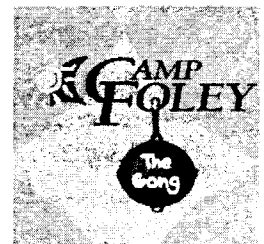

**If you like what you hear - add a review in iTunes! Help us spread the word!**



# Wolf Campers (13 and up)!

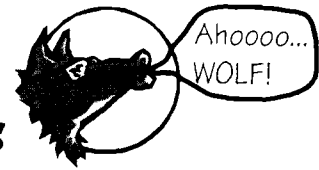

## Leadership Program

Space is Limited - Get Your Forms in Today!

The Leadership Program (LIT, LIT2, LIT3 and CIT) is once again off and running! We currently have over 60 kids enrolled in the program and many sessions are full or beginning to fill! If you are a returning camper going into 9th-11th grade -

**Sign Up Today!** Please check the website for the current information!



As part of the program you will have an opportunity to enhance your leadership skills, practice facilitating events and programs for other campers, be a role model for the younger kids and learn some of the skills needed to be a counselor one day!

## Backpack Trip

### Pre-Registration Required!

**Wanted:** Campers 13 years of age or older who like to hike & camp!

**What:** 3 days, 2 nights backpacking trip

**Where:** The Beautiful Lake Superior Hiking Trail

**When:** One time a session

**Why:** Because it will be the experience of a lifetime!

We need a minimum of **8 participants per session** in order to send the trip - talk to your friends! **Contact the camp office for more details!** The form is available online and will be in the next mailing! For more information, check out the website under the **Download Forms** section.

Come and be apart of... "The Few...The Proud... The Foley Backpackers!"

**Help us continue to pass on the traditions of Foley!**

## Dishwashers (14 and UP)

Do you like making **MONEY** and **FRIENDS**? Are you 14 years old or older? If so, than dishwashing is for you! You can build your resume while getting money off your tuition! Sign up for either 6 or 12 washing times. For more information, go to the website under the **Download Forms** section. We'll see you in the dish room!



**2008 Dishwashers (so far):** Rachel Westra, Matt Kronschnabel, Courtney Kronschnabel, Marnie Brown, Katie McGuire, Armando Scala, Jeff Pflanz, Hannah Keogh, Julia Gesensway, Jack Revord, Joe Dwyer & Kylie Beltz

### Do you need another opinion?

This is what one of our past dishwashers had to say... "I was at church yesterday we were doing a fundraiser, and in the kitchen they have a Hobart dishwasher, and everyone was impressed that I knew what to do when you were done with the dishes... by lifting that one thinger inside and cleaning out the drain! I was so proud! Thank you Camp Foley for another important life lesson - dishwashing!"  
**Krista S, 11 year camper**



## Session Availability

Many sessions are already filled up or are getting very close to being full! Register Now!

### We have space in the following sessions:

- June 17-July 15 (four weeks) \*Limited for girls; Space for boys
- June 17 - 30 (two weeks) \*Limited for girls; Space for boys
- July 1 - 14 (two weeks) \*Space for boys and girls
- August 13-17 (5 days) \*Space for boys and girls; 12 & Under

Due to plans changing for the summer we do get cancellations occasionally. Please check the website or call for availability.

Go to [www.campfoley.com](http://www.campfoley.com) for weekly updates under **Session Dates and Rates.**

# Summer 2008: Fabulous

## Banquets!

Sessions 1 & 3 - June 17-30 & July 16-29:

**\*This is also the theme for the 2nd 1 week session.**

Get ready for a Foley Fiesta! In honor of all our campers from Mexico we are throwing the Foley version of a true Mexican Fiesta! Pinatas, maracas and sombreros! Come show spirit for our neighbors to the south. Dress either in traditional gear (ponchos, sombreros) or the colors of the Mexican Flag - Red, Green and White! The day

will be spent playing popular games from Mexico and learning all about their culture!

### Mexican Fiesta



campers from Mexico we are throwing the Foley version of a true Mexican Fiesta! Pinatas, maracas and sombreros! Come show spirit for our neighbors to the south. Dress either in traditional gear (ponchos, sombreros) or the colors of the Mexican Flag - Red, Green and White! The day

## Grand Dance Festival!

We have listened to your suggestions and this year we have once again decided to make the theme of the Grand Dance Festival known to you all before you



come to camp! As with other years, the dance festival has a little bit of everything. Tennis, volleyball, human foosball, pool, ping-pong and of course - Dancing! We have decided on a theme of "Nerds"! Of course in keeping with our goal of having you all be involved in everything at camp, this theme came from many of the surveys and conversations from last summer! Find some sus-

penders, hats with spinners on the top, tall socks, etc. Layer your clothes or wear lots of different colors!

## Camp Clubs

Last summer the "Running Club" at camp took off and had 20 members or more by the end of 4th session, so we thought it would be fun to think of some other clubs that campers and staff may want to be a part of! Being part of a club can be fun and mysterious! Have you always wanted to try **Yoga**? Or learn how to tie a **fly for fly fishing**? Learn how to play **croquet**? Or perhaps create some of the segments for the Foley Podcast, "**The Gong**"? This is your chance! A couple times throughout the session you will have the opportunity to **spend time with a club of your choice and learn all about a special skill or interest that you have!** We will be calling on all of our wonderful staff to share their talents with you and if you have any ideas let us know!



Sessions 2 & 4 - July 1-14 & July 30-August 12:

Summertime Thanksgiving! Although the traditional American holiday is usually celebrated in November we thought it would be fun to put a summertime twist on it. Will you help create a re-enactment of the first Thanksgiving? Perhaps join in the Foley Thanksgiving Day Parade? Or is football more your thing? The possibilities are endless! Dress in traditional Thanksgiving gear or come as your favorite balloon from the Macy's Thanksgiving Day parade! You can even dress as your favorite Thanksgiving food, football team or wear your favorite Turkey adorned sweater!

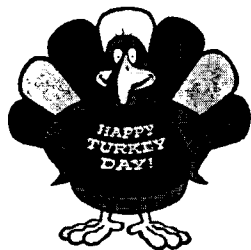

## Game Show Mania!

The Price is Right! Deal or No Deal! Jeopardy! The Family Feud! Double Dare! Game shows are everywhere! This summer at Foley we will have our own versions of classic game shows as well as some of the newer ones on T.V. Try your hand at guessing prices of random things around camp. Answer history questions about Foley. Challenge your friends to physical and mental challenges. There will be a little of something for everyone! You never know you may even walk away the Grand Master Champion....



# Programs and New Stuff!

## 4th of July, 2008!

It has been 3 years since we have had a full session going on over the 4th of July and we are excited to get back to **celebrating Foley style!** We are going to be mixing some of the old classic Foley stuff (costume contests, skits and of course singing all of those great American classics like Yankee Doodle) with some new ideas. Perhaps we will do some debating? Or make campaign buttons for ourselves? Who said we can't run this country!? Whatever we decide to do, be sure to bring your red, white and blue and be ready to celebrate our Independence in style!



## Slackline!

Balance. Concentration. Flexibility. Do you have what it takes to make it across the Slackline? What is Slacklining you might ask? It is a sport that has a surprisingly big following where a piece of nylon webbing (sort of like rope) is attached to two objects (trees, posts, boulders, etc) but instead of making it tight like a tightrope, it is loose. The object is to get from one end of the line to the other without stepping off on to the ground. Come give it a shot!



## Improvements!

You asked for it! You got it! Besides the cool stuff on Page 1, here are a few other things that will be NEW to the activity areas this year!

- \* New **Canoes**
- \* New **targets & arrows** for Archery!
- \* New **sidewalks** on the boy's end!
- \* New **trick skis** for the expert ski award!
- \* New **scroll saw & belt sander** for shop class!
- \* New **windsurfing sails!**
- \* New **gun rests** for the beginner rifle shooters.
- \* Another set of **Treehouses!**
- \* New **Van** for Tripping!

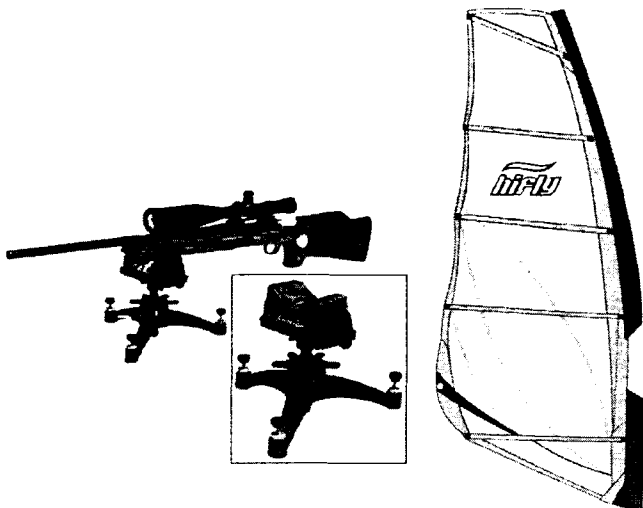

## Tips from the Pros!

**Words of wisdom from past campers & staff:**

\*Pack Light!

\*Don't forget that shower caddie and laundry bag to help you get organized.

\*Need a softer bed? Bring a quilted mattress cover or use your sleeping bag under your fitted sheet as a mattress cover.

\*Bring T-shirts and bandanas of different colors for when we make teams! Try to bring a variety!

\*Don't forget your costumes for the banquets, special days and dances!

\*Remember a good flashlight - you will use it!



# Meet Some 2008 Staff!

**As of March 4th, 2008! Keep Checking the Website for Updates!**

**Molly B** - is headed to Foley for her first summer! Molly is currently a student at Notre Dame and is still trying to decide on a major. This summer she will be down at the waterfront working as a lifeguard and helping to run the swimdock.

**Jessie B** - is coming back to Foley for her second summer. You probably remember Jessie as the mighty leader of the "Running Club". Jessie will be back to keep all the Foley athletes in shape as well as to teach riflery and be a paintball ref! Jessie is currently in her sophomore year at Carleton College in Northfield, MN where she is a sociology and anthropology major.

**Sara B** - will be back for her second summer at Foley! Sara is currently a Junior at the University of Wisconsin LaCrosse where she is a pre-nursing major. She will be back at camp to teach Crafts, Climbing and to be a lifeguard at the swimdock!

**Laura C** - is ready to return for her third summer at camp! Laura will of course be back to teach nature and crafts but this year will be up at paintball doing some refereeing. Laura is currently finishing up her junior year at the University of Northern Colorado where she is an Elementary Education and Geography major.

**Tracey C** - will be at Foley for her first summer! Tracey is currently a sophomore at St. Mary's College in Indiana where she is majoring in Psychology and Communicative Disorders. At camp this summer Tracey will be helping out with climbing and archery!

**Travis C** - is also going to be a first time counselor this summer. Travis will be teaching archery and is excited about doing some drama as well! He is currently a freshman at University of Minnesota Duluth where he is majoring in business with a focus on healthcare management!

**Lorenzo D** - is a first year counselor this summer! He will be working in the shop as well as up at paintball. Lorenzo is currently sophomore at St. Mary's University in Winona, MN where he is majoring in History.

**Jenny D** - is back for her third summer at Foley! Jenny will once again be working with the LIT and CITs as well as down at the waterfront teaching canoeing, snorkeling and lifeguarding. Currently she is finishing her senior year at the University of Minnesota where she is majoring in Child Psychology and Youth Studies.

**Malin F** - will return to Foley as a counselor for her first summer (she was a camper for two summers). Malin comes all the way from Stockholm, Sweden to teach climbing and sailing. She currently is finishing the equivalent of her senior year of High School and coaching gymnastics!

**Sean G** - is coming back to Foley for his second summer! Sean is currently in his senior year at the University of Wisconsin at Eau Claire where he is majoring in Political Science. Sean will be back at the Marina as a Marina Leader and to teach fishing as well as waterskiing.

**Jen G** - will be a first year counselor this summer! Jen is a senior at Winona State University in Minnesota where she is majoring in Elementary and Early Childhood Education. She will be teaching dance, crafts and climbing at camp this summer!

**Nikki J** - is going to be back at Foley for the month of May (any of you OLG or Annunciation 6th graders that are coming up in May will see her). Nikki is a junior at Western Michigan University majoring in occupational therapy.

**Wes L** - is a first time Foley staff member this year. Wes is currently in Cullman, Alabama where he is studying flight technology with the hopes of being a flight instructor someday. At camp Wes will be down at the Marina teaching waterskiing & wakeboarding as well as up at paintball as a ref.

**Chris M** - will be a first time Foley counselor this summer! Chris is currently in his fourth year of college at South Dakota State University in Brookings where he is majoring in Public Recreation and Business. Chris will be teaching sports as well as riflery!

**Maddi Mc** - will be a first time Foley staff member this summer as well! Maddi will be teaching climbing as well as tennis. Currently she is a sophomore at St. Mary's College in Indiana where she is communications major.

**John M** - is headed to Foley for his first summer. John is currently a freshman at North Dakota State University where he is majoring in Agricultural Education. John will be working on all those great shop projects with you as well as teaching woodskills!

**Aaron N** - will be back for his second year at camp to teach riflery, trap and this year do some tennis as well! Aaron is currently a sophomore at Trinity Bible College in North Dakota where he is majoring in Secondary Education.

**Annie O** - is headed back to Foley for her second summer! Annie is currently a junior at Bradley University in Peoria, IL where she is a social work major. Annie will be helping create all of those great crafts projects as well as going back to be a paintball ref.

**Ricky P** - is back and ready for some more paintball action! Ricky is currently a senior at the University of Iowa in Iowa City where he is majoring in Political Science and Religious Studies. Besides paintball, Ricky will be helping out as a lifeguard and a variety of other areas!

**Calie R** - is a first time Foley counselor. Calie will be helping prepare all those great Foley meals working as a kitchen assistant and also helping out at a variety of activities. Currently she is a freshman at Midwestern State University in Wichita Falls, Texas.

**Caralyn S** - will be a first year counselor at Foley this summer. Caralyn will be working as an assistant cook this summer as well as helping out at a variety of activities. She graduated from The Cooking and Hospitality Institute of Chicago with degree in Culinary Arts. She is now working toward a business degree!

**Kirk S** - is a first time Foley counselor that will be helping to head up the Paintball program as well as teaching riflery. Kirk is currently finishing up his senior year at the University of Iowa where he majored in Management.

**Nikki S** - is a first time counselor that will be heading up our Fencing program this summer as well as helping out with a little trap! Nikki is currently a sophomore at the University of Iowa where she is majoring in creative writing and theatre arts.

**Becky W** - is a first time Foley counselor who will be a lifeguard and also teaching canoeing. Currently she is in her first year at Century Community College in Mahtomedi, MN where she is still trying to decide between being a teacher and a pediatric nurse.

**Laura W** - will be at Foley for her first summer! Laura is currently a senior at Creighton University and is majoring in Elementary Education. Laura will be down at the waterfront this summer teaching waterskiing and lifeguarding.



# Look Who's Registered

As of March 7, 2008!

**A** Quinn Abrams, Lucas Absolon, Effie Albitz, Jackson Amodeo, David Ancer, Grace Armacost, Gonzalo Arrangoiz **B** Henry Bacon, Olivia Bacon, Laura Baker, Chantelle Bannister, Joshua Bannister, Allison Barker, Paul Barnes, William Barnes, Javier Barreda, Molly Bauer, Paxton Bauer, Emily Beh, Megan Beh, Kevin Beltz, Kylie Beltz, Spencer Bemel, Gaston Benitez, Thomas Bergen, Justin Bergerson, Vince Biaggio, Anna Bins, Matthew Bohannon, Mckenna Bolger, John Bouchard, Grace Boyd, Madeline Boyd, Nicole Boyd, Andrew Bradley, Ford Brandau, Mia Brennan, AJ Brown, Elizabeth Brown, James Brown, Jessie Brown, Julia Brown, Kentrell Brown, Marnie Brown, Vic Bruene, Sutton Bryan, Blaise Bucey, Dwyer Bucey, Dane Buchman, Jonathan Buchman, Katie Buenneke, Alice Buren, Daniel Burford, Brendan Burke, Ian Burke, William Burke, Jeremy Burling, Mariah Byrd, **C** Nick Cadle, Sophia Cadle, Reed Caldwell, Antonio Camiro, Maria Elena Camiro, Andres Campbell, Sydney Carlson, Charlotte Carlton, Olivia Carlton, Matthew Carney, Jamie Carter, Claire Castaneda, Isabella Cattori, Pedro Cattori, Sarah Champeau, William Chmielewski, Brennan Clark, Madeleine Clark, Alicia Clow, Zachary Clow, Riann Colbert, Catherine Cole, John Combs, Katie Commers, Rachel Conley, Michelle Conway, Natalie Cooper, Anna Copman, Samuel Copman, Jacob Courtney, Megan Covington **D** Ally Daily, John Daily, Jens Damgaard, Margaret Dankmyer, Sarah Danson, Alex Davis, Laura Davis, Stephen Davis, Frannie Deckas, Caroline Degnan, Abby Deutz, Ana Gabriela Dieck, Guillermo Dieck, Ivonne Dieck, Anna Digman, Cassidy Dinkins, Elizabeth Dolinsky, Mick Donahue, Carter Downs, Emily Draper, Stefanie Draper, Alex Driessen, Tali Driessen, Abby Dryer, Walter Duff, Alexandra Dulles, Brady Duncan, Mimi Dwan, Elizabeth Dwyer, Joe Dwyer **E** Connor Eastman, Jessica Eastman, Ethan Eiler, Claudia Eisenhuth, Gabe Eisenhuth, Annie Epstein, William Erickson, Jake Ernst, Matthew Ernst, Paige Ernst, Madeline Esteb **F** Conor Failor, Jack Failor, Cosette Falke, Jordan Fallon, Kaitlin Faoro, Juan Farais, Gaby Feltner, Mia Fernstrom, Sebastian Ferrero, Melissa Ferrie, Joe FitzPatrick, Meggie Flinn, Regina Flores, Erin Foley, Mark Foley, Sam Folkman, Jack Foster, Danny Foussard, Sydney Foy, Etienne Francis-Venet, Katie Freeman, John Freiberg, Helen Friberg, Coco Fritzlen, Maria Frogelius **G** Nicholas Gabanski, Nick Gaither, Andrew Gallagher, Charlie Gamer, Rachel Gans, Daniel Garcia, Jorge Garcia, Brianna Garcia-Meyers, Madison Gartner, Marlee Gartner, Chase George, Riley George, Alexander Gerrard, Grace Gerrard, Elizabeth Gesensway, Julia Gesensway, Patrick Gibbs, Sarah Gibbs, Gus Glab, Toby Glover, Julia Goldman, Nicholas Goldman, Alejandra GomezJunco, Kathryn Graf, Devan Graham, Andrew Grant, Billy Grant, Caden Grebin, Catherine Griesedieck, Michael Guckeen, Tyler Guckeen, Gaspard Guerand, Mauricio Guerrero, David Guillen, Diana Guillen, Charlie Gusho, Halle Gusho, Aaron Gustafson, Lucy Gworek, Yanna Gworek **H** Jonathan Hahn, Sarah Haley, Archie Hamel, Jack Hamel, Susie Hamman, Kevin Hannigan, John Harper, Lauren Harper, Brittany Harrington, Margaret Harrington, Paige Harrington, Parker Harrington, Collin Harris, Maddie Harris, John Hartfiel, Madeleine Hartmann, Ari Hechter, Anna Heinemann, Katherine Hendricks, Peter Henkhaus, Jose Hernandez, Collin Heselton, Jessica Hickok, Isabeau Hill, Mark Hill, Mary Hill, Mia Hill, Madeline Hinct, Emily Hines, Sarah Hines, Casey Hinken, Alexis Hoedeman, Nick Hoefel, Jake Hohne, Justin Hohne, Danny Holmes, Miles Holt, Susie Holt, Hannah Honeycutt, John Horan, Erik Horstman, Claire Howes, Jessica Howes, Casey Hudak, Madeline Hudak, Greg Huey, Peter Hughes, David Husband, Sarah Huss, Gracia Hutson, Harrison Hutter, Katherine Hutter **I** Audrey Imbs, Cole Imbs, Mac Irvine, Tyler Isaacs, Christopher Ivins, Lauren Ivins, Victoria Ivins **J** Cameron Jackson, Patricia Jackson, Caroline Jaeger, Anders Jensen, Dane Jensen, Abigail Johnson, Avery Johnson, Ian Johnson, Josephine Johnson, Kallen Johnson, Lars Johnson, Sophie Johnson **K** Sarah Karels, Henry Kauth, Adam Kay, Kathleen Kenny, Bailey Keogh, Hannah Keogh, Casey Kerin, Dani Kerin, Taylor Kiffin, Tia King, Payton Kinkead, Kira Kirby, Niklas Koch, Katya Kravchenko, William Krebsbach, Mariah Krey, Bridget Kritz, Madelyn Kritz, Courtney Kronschnabel, Emilia Kronschnabel, Matt Kronschnabel, Nick Kronschnabel, Tory Kronschnabel, Kevin Kruemplestaedter, Sara Kruemplestaedter, Kate Kugler, Helen Kuhn, Jack Kunkel, Lauren Kunkel **L** Kate LaMair, Anne Lambertson, Lindsey Lande, Eliana Langer, Nick Lavezzorio, Mohammed Lawal, Gannon Lee, Mary Lee, Matthew Lee, Alex Leever, Sophie Lehmann, Claudia Leon de la Vega, Courtney Lilly, Drue Lindstrom, Miranda Lockner, Isabella Loosbrock, Madeleine Loosbrock, Travis Louhi, Sydney Lovrien **M** Victor Ma, Natalie MacIntosh, Turner MacIntosh, Colleen Mahoney, Ellie Mahoney, TJ Mahoney, Lucas Maloney, Claire Mancheski, Eleanor Mancheski, Gabriela Marcos, Patricio Marcos, Peter Markee, Madeleine Martine, Carlos Martinez, Karla Martinez, Michael Mathis, Christopher Mayers, Joe Mays, Lilly McCarty, Rosie McCarty, Zachary McCormick, Margaret McDonnell, Emily McGuire, Katie McGuire, Megan McGuire, Molly McGuire, Shannon McGuire, Lindsay McKerr, Tessa McKerr, Lucy Melbinger, Alex Meneses, William Merriam, Matthew Meshbesher, Katie Meyer, Caroline Michalek, Cole Michalek, Hannah Michalek, Kevin Mickan, Alex Miley, Ryan Miley, Lisa Miller, Elizabeth Miotti, Brent Mitchell, Kevin Moakley, Sean Moakley, Hannah Moen, Bridget Moffet, Caroline Moore, Robert Moore, Roman Moore, Jesus Moreno, Rachel Morris, Alex Moskowitz, Chase Mueller, Erik Mueller, Molly Munderloh, Jack Munkeby, Joe Munkeby, Mae Munkeby, Sam Munkeby **N** Maria Alesandra Naranjo, Enrique Navarro, Everett Naylor, Bailey Ness, Andrew Netzel, Elliot Newman, Emily Newman, Eric Newman, Addie Newsome, Marjorie Newsome, Connor Nickelson, Alexandra Niebur, Susan Nitschke, Jake Noch, Reid Noch, Braze Nolin, Quinn Nolin, Chase Nordstrom **O** Caroline O'Brien, Callan O'Connor, Ben O'Malley, Chris O'Malley, Analise Ober, Andrea Offeren, Elizabeth Olson, Evan Oncay, Grant Oncay, Aden Opland, Tage Opland, Krista Opp, Andres Ornelas, Rodrigo Ornelas, Diego Orta, Gerardo Orta, Juan Pablo Orta, Stephen Osborne, Lars Oslund, Caroline Ott, Elizabeth Ott **P** Annie Padgitt, Nick Padgitt, Tyler Palmquist, Julia Parkerson, Anne Parrish, Evan Patchen, Kaeli Patchen, Katie Patrick, John Pauly, Jack Pawlik, Michelle Pazin, Alexis Peltier, Calvin Perkins, Kathryn Peterson, Zander Peterson, Jeff Pffanz, Parker Poché, Juliet Prine, Lily Prine, Eliot Pulling **Q** Gabriela Quintero **R** Grace Redpath, Hannah Redpath, Danny Reiling, Jessica Reinhart, Christopher Revord, Claire Revord, Jack Revord, Michael Revord, Grace Rewey, EJ Reynolds, Will Reynolds, Robbie Rice, Jenna Riley, Alejandra Rios, Patricia Rios, Will Robertson, Jack Romans, Sarah Romans, Calvin Rose, Samuel Rosenberg, Emma Rowland, Peter Rowland, Enrique Ruiz, Guillermo Rumbaut, Sammy Russell, Michael Rutzick, Alex Ryan, Chase Ryan, Emma Ryan, Jackson Ryan, Karli Ryan **S** Michelle Sainz, Jonah Sandy, Samuel Sansone, Armando Scala, Claudia Scala, Emma Schaffer, Leah Schaffer, Charlie Scheitlin, Thomas Schelble, Eric Schmid, Megan Schmidt, Spencer Schramm, Frances Schroeder, Mackenzie Schroeder, Thomas Schroeder, Caroline Schuler, Mary Grace Schuler, Jonah Schwartz, Emily Sciortino, Mary Claire Seeberg, Jack Selzer, Rose Shaffer, Emily Shandorf, Bryn Shank, Katie Shaughnessy, Andrew Shumway, Olivia Sieff, Ben Sigel, Ellie Sigel, Danielle Sikora, Alyson Sklare, Olivia Smith, Sam Sonnier, Olivia Spellmire, Cole Spencer, Tate Spencer, Alexander Sprangers, Cole St. John, Nicholas St. John, Ryan St. John, Evan Stafford, Annie Steiner, Gretta Steiner, Helen Steiner, Hannah Stevens, Jill Stevens, Clare Stoddart, John Stone, Thomas Stone, Daniel Suchsland, Philip Swanson, James Sweeney **T** Jack Taylor, Kelsey Thomas, Liesl Thome, Jack Thompson, Bridget Thomson, Brooke Tinsman, Clare Toner, Katie Toner, Katie Tooley, Katie Traub, Juan Pablo Trevino, Taylor Tufano, Sara Turke, Alex Tyler **U** Simon Uhm, Xander Uhm **V** Inigo Valenzuela, Mariana Valenzuela, Karl Vanstrum, Maddie Vill, Alejandra Villarreal, Eugenio Villarreal, Franci Volpi, Hedvig Von Essen, Oscar Von Essen **W** Emily Wack, Charlie Walden, Jack Walden, Luke Walden, Jay Wallace, Julia Wallace, Peter Wallace, Marena Wallschlaeger, Nika Wallschlaeger, Jack Walsh, Rachel Walter, Grant Weis, Haley Weis, Hunter Weis, Jack Welch, Robbie Welch, Rachel Westra, Steven Westra, Anne Wheeler, Joseph Wheeler, CJ Whitaker, Drew Whitaker, Grant Whitaker, Kendall Williamson, Anderson Winslow, Katie Winslow, Jordan Winter, Austin Wolfe, Lizzy Wolfe, Vivian Wolkoff, Connor Wright, Margot Wright, Spencer Wright **Y** Tristan Yorek **Z** Cami Zecker, Joe Zirnheit, Maggie Zirnheit, Alex Zwaschka





Make your summer SIZZLE!

9303 Father Foley Drive  
Pine River, MN 56474

BULK RATE  
U.S. POSTAGE  
PAID  
PINE RIVER MN  
PERMIT NO. 72

Address Service Requested

**In This Issue**

- New In 2008
- Partnering with Parents
- Meet the Staff
- Look Who's Registered



Make your summer SIZZLE!

9303 Father Foley Drive  
Pine River, MN 56474

**Tell Your Friends About Foley!**

Do you know someone looking for fun, friendships and new skills? Share with them your memorable experiences of Camp Foley and encourage them to register. So... tell your friends and family!

**Send Information Immediately To:**

Last Name \_\_\_\_\_ Home Phone (\_\_\_\_\_) \_\_\_\_\_

Father's Name \_\_\_\_\_ Mother's Name \_\_\_\_\_

Address \_\_\_\_\_

Children's Names & Grades \_\_\_\_\_

\_\_\_\_\_

\_\_\_\_\_

Referred by \_\_\_\_\_





# CAMP FOLEY™

November 2008

## Make your summer **SIZZLE!**

### Dressing up for the Holidays...



## Foley Style!



This summer we celebrated a Mexican Fiesta and Thanksgiving. We got all dressed up like Nerds for the dance and faced off against the Gladiators. We had spa night complete with cucumbers and even had time to take in Foley's American Idol! Here is a look at all those great costumes!





# 2008 Honors

## Silver Paddle Award

Created in 1969, the Silver Paddle is the highest honor a camper aged twelve and younger can achieve at Foley. Not only must you receive awards in a variety of camp activities but you also must be a person of good character and a role model for the other campers.

We would like to congratulate **Jack Hamel** on receiving his Silver Paddle this past summer. Jack is only the 42nd camper to receive the Silver Paddle and it is a big accomplishment! Well done, Jack!



Antonio Camiro



Isabella Loosbrock

## Birchbark Awards

The Birchbark Awards are awarded to campers who complete at least half of the requirements for the Silver or Gold Paddle. The Paddle Awards are for those campers that have achieved a rounded development in the various activities offered at camp and who have followed Foley's Code of Living. For 2008, we would like to recognize **Isabella Loosbrock** for putting forth the effort to complete the requirements for the Silver Birchbark Award. Hats off to **Antonio Camiro** for his diligence in earning his Gold Birchbark Award! Congrats!

## Activity Achievements

From our 2008 summer, we would like to recognize the following campers who received the highest award offered in the activity:

- Expert in Waterskiing – **Bridget Moffet**
- Skipper in Sailing – **Kylie Beltz, Coco Fritzlen and Tali Driessen**
- American Archer in Archery – **Gus Glab**
- Flying Eagle in Diving – **James Brown**
- Advanced in Canoeing – **Archie Hamel, Michael Rutzick, and Caroline Schuler**
- Beaver in Snorkeling- **Emily Beh, Mckenna Bolger, Josephine Johnson, Henry Kauth, Bridget Kritz, Lauren Kunkel, Lilly McCarty, Emily McGuire, Katie Patrick, Mary Grace Schuler, and Olivia Sieff**
- Advanced Foil in Fencing – **Thomas Bergen, Sean Cook, Ally Daily, Brady Duncan, Tyler Fernstrom, John Freiberg, Sean Flynn, Danny Holmes, Cameron Jackson, Isaac Lauer, Alex Leever, Brent Mitchell, Elizabeth Miotti, Jesus Moreno, Jack Munkeby, Ben O'Malley, Juan Pablo Orta, Ryan Simmons, Casey Spinelli, and Alexander Sprangers**
- Shark in Swimming – **Elizabeth Brown, Stephen Davis, Tali Driessen, Kirill Fox, Nicholas Goldman, Jack Hamel, Madelyn Kritz, Claudia Leon de la Vega, Lilly McCarty and Brent Mitchell**

The following campers achieved the highest award in each respective activity for this summer!

- Rock Hopper in Biking – **William Krebsbach, Cole Michalek, Cole Spencer, Jack Walsh, and Jay Wallace**
- Daggerboard in Windsurfing – **Greg Huey**
- Sharpshooter #2 in Riflery – **Antonio Camiro and Billy Krebsbach**
- Advanced Intermediate in Tennis – **Stephen Davis, Kevin Mickan, Michael Revord, Michael Rutzick, CJ Whitaker, and Drew Whitaker**

Congratulations to all of our campers who achieved awards this summer. Many ribbons were given out and we had many, many smiling faces at the Awards Campfire. 2009 is your summer to continue onward and accomplish another award.



# Bridge Crossing Essays

(Excerpts from the 2008 Bridge Crossing Essays)

The qualifications needed for the Bridge Crossing are attendance at Foley for at least 5 years and completion of the "What Camp Foley Means to Me" essay. There were many campers who were eligible for this honor, and we would like to thank the 10 campers who decided to take the time to put their Foley experience into words by completing the essay. Congratulations!

Gracia Hutson



I think that I'd be a different person without camp. Every year I seem to lose myself but when I come here I remember who I am. Every year I've been here I've met great role models and learned many lessons.

Stephen Davis



I believe the heart of Camp Foley is freedom, imagination, and equality...The final part of camp is equality. Let's be honest, how many of us are treated better here than at school by other kids? I know I sure am! Everyone is equal here at camp.

Bridget Moffet



I believe that being a leader is one of the best characteristics that a person can possess in life. The fact that Camp Foley can provide me with the chance to learn how to be one is so amazing.

Matt Kronschnabel



...Camp can make the most timid of people into confident, outgoing leaders. The atmosphere that camp provides allows people to be themselves, voice their opinion, and share ideas without prejudice.

Emily Newman



The first thing that I love about camp is the people. Whenever I have been down or homesick all I would have to do is look beside me and I would see a smiling face ready to listen and help me out. The counselors and directors are pretty much super fantabulous. NEVER have they let me down.



Mia Fernstrom

I have come all the way from Japan every year since I was seven. Which is so worth it. And I have the time of my life here at Camp Foley. Every year I come back to camp and always, ALWAYS think home sweet home.



Brady Duncan

The thought of Camp Foley keeps me motivated throughout the year to do well in school and stay out of trouble.



Will Burke

Camp is the only place I know that has such a high power to bring such a diverse group of people together. Camp has changed and influenced me so much to the person I am today.



Aly Sklare

The laughing at camp is a constant. That's one of the things I think of when I think of Foley, laughter. Everyday there is something to laugh about. Even when I tell stories from years past, from stupid things I have done to the funny things, we all remember and it brings laughter and smiles to our faces.



Archie Hamel

There is a feeling there that is unmatched by any other feeling in the world even if it was a small accomplishment it still feels great and the best part is the people around you congratulating you for your great accomplishment. This feeling is unmatched, unequal and the most uplifting. And there is always a higher and more difficult goal to shoot for so you can always push yourself.

If 2009 will be your 5th summer or more, you are invited to become part of the Bridge Crossing group. To become a member, you need to write an essay of 500 words or more on "What Camp Foley Means to Me?". Submit your essay to Camp Foley. Hint - do your essay this winter!

## Stepping Stones

The qualification needed for the Stepping Stones is attendance at Foley for at least 3 years. The 2008 campers who received this recognition signed a special board that is hanging in the Dining Hall. Congratulations to all of those campers! It was impressive!



# 2008 Honors (continued)

## Hall of Fame

Besides our traditional activity awards and Anchor awards that were distributed to deserving campers, The Hall of Fame is another important achievement. To obtain this recognition, a person needs to spend 10 summers at Foley as a camper and/or counselor or combination of the two.

Bridget Moffet celebrated her 10th year at Foley this summer and was inducted in to the Camp Foley Hall of Fame! Bridget is a second generation camper who first came to Foley as a 5 year old back in 1999.

Although she doesn't remember much of those early days, she remembers having an "awesome" time. In 2001, her highlight was the Harry Potter Banquet and winning the costume contest.

Starting in 2002 she met many of the girls that she is still coming back to camp to see and the same group has "grown up" together in a cabin ever since.

It has been great having Bridget in camp and we all agree that she embodies the Foley spirit!



## Anchor Award

The Anchor Award is an award that honors outstanding campers who demonstrate qualities of being friendly, well mannered, respectful, and enthusiastic. All nominees for the award must have attended camp for a minimum of 5 weeks. The recipients are chosen by written vote of both the campers and staff during each session. The 2008 Anchor Awards were presented to the following campers:



1st Session  
Sarah Gibbs & Casey Hudak

2nd Session  
Kylie Beltz & Patrick Gibbs



3rd Session  
Rosie McCarty & Erik Mueller



4th Session  
Emilia Kronschnabel & Matt Kronschnabel



A collection of past Anchor Award winners

## Coming in December

2008 Campers should watch the mail for the picture CD of all of the camp pictures and a calendar full of colored pictures from the summer of 2008.

## Pictures!

To see more pictures from the summer of 2008, go to our web site: [www.campfoley.com](http://www.campfoley.com).



# Parent Comments!

After each summer we ask our parents to share comments and feedback with us about their child's experience at Foley. Here are a few of those comments from the summer of 2008!

"I can't describe the pleasure we get from seeing the positive results following a summer at Foley. [My daughter] grows more every summer she 's there and Foley has contributed enormously in providing an environment for her to exercise her leadership, social and physical skills...The highlight of our summer was getting to visit Foley when we picked up our daughter. We were so impressed with the beautiful and intimate environment. I completely understand why the kids feel so at home there..." *Mother of 4th Year Camper - Illinois*



"My husband and I want really to thank you and all your team for the wonderful camping experience [our children] had this summer. It was their first time at camp and they were really worried about going. We were surprised how fast they adapted to the camp. They came back to us very happy. They liked their counselors a lot, they loved the activities, the food, friends...well everything. They miss the camp. We really appreciate that you made their first time alone, out of our home, such a wonderful experience. Thank you very much." *Mother of 1st year campers - Mexico*



"Our son absolutely loved camp. This was his first time at camp and his first time away from home for more than a day or 2. We noticed that he is much more confident in himself since returning home. He discovered that he is capable of doing numerous things he always said "I can't" about or wouldn't even consider attempting." *Parents of 1st time camper - Nebraska*

"Before camp,[our daughter] didn't really want to go, and when she got back from the 2 week session, the first thing she said was "Next summer, I want to go for 4 weeks"!!! She absolutely loved Camp Foley." *Mother of 1st Year Camper - Missouri*



"Another fabulous year for the boys at Foley! My older son told me that he really learned how to be a good leader and how to accept people from all cultures. The boys always come home after their month away so changed. They have grown in height, maturity, self confidence and faith. What a great, great resource! We love Foley!!" *Mother of 5th year campers - Minnesota*

[My daughter's counselor] was a shining star in [my daughter's] life. She spoke of her with such enthusiasm about what a great, positive, fun, outgoing counselor she was!.. Thanks for another great year!!" *Mother of 6th year camper- Minnesota*

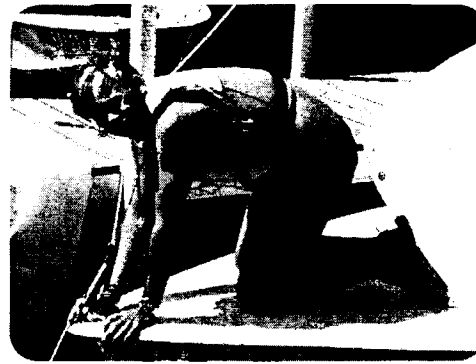

## Feedback

It is not too late! We would still love to hear from you. Send in the parent comment form or simply shoot us an email. Thanks to everyone that already sent in comments!

# Leadership Program – Thank You!

Once again we had a record number of campers who successfully completed the various levels of the Leadership Program! A big thank you to these campers who used their leadership skills in a variety of ways from leading evening programs to helping to decorate for the banquets! You were appreciated.

## LITs 1, LITs 2, and LITs 3 2008

The LIT 1, 2 and 3's were responsible for a lot of great things this summer! They practiced leadership skills while doing games and initiatives with their peers as well as the younger campers. They led activities with the other Wolves, with the Coyotes and with the Foxes. We also went over to Camp Knutson again this summer (a camp near Foley that specializes in special needs kids) to help out for an evening. It was an experience that both the Foley campers as well as the kids at Camp Knutson will remember for the rest of their lives!

In addition the older LIT 2's or 3's joined our CIT's to help out at Habitat for Humanity for a day. They helped with some of the staining and sanding of parts of the house that is being built. It was a great experience for them to help out in the community around camp.

We are now taking applications to be part of the LIT program for next summer! You can find all the forms you need in the *Download Forms* section of the website. Let us know if you have any questions!



*Camp Knutson fun*

## Counselors in Training 2008

These campers were going into 11<sup>th</sup> grade and were at camp for four weeks. They made a commitment to focus their leadership and time with our younger campers. They assisted these campers in their cabins, at their tables, and in their activities. A very special thank you to these CIT's! They were role models and friends to our younger campers. Many times we hear, "I'm going to be just like them when I grow up and be a CIT!" A big thank you to Greg Huey, Casey Hudak, Antonio Camiro, Katie Buenneke, Tali Driessen, Rosie McCarty, Sarah Hines, Emilia Kronschnabel, Matt Kronschnabel, and Erik Mueller.

Are you interested in being a CIT and will be going into 11<sup>th</sup> grade next year? Apply today - find all the forms on the website!



*Working hard at Habitat for Humanity*



*The crew outside Habitat for Humanity*



*LIT's helping at Camp Knutson*

## Dishwashers 2008

On those hot summer days, we had a wonderful crew of campers who worked off some of their camp tuition while doing dishes. The following campers enhanced on their work experience while helping out the camp community: Rachel Westra, Will Crawford, Eric Mullis, David Mullis, Armando Scala, Kylie Beltz, Lisa Miller, Evan Simmons, Parker Poche, Alex Ryan, Claudia Scala, Sarah Champeau, Andrea Offerson, Kevin Beltz, Rodrigo Ornelas, Andres Ornelas, Courtney Kronschnabel, Matt Kronschnabel, Megan Schmidt, Allie Dulles, Jeff Pflanz, Marnie Brown, Katie McGuire, Julia Gesensway, Jack Revord, Joe Fitzpatrick, Joe Dwyer, Will Robertson, Chase Nordstrom, and Claire Castaneda. You were truly appreciated!!

You can be a dishwasher if you will be 14 years of age or older by the time camp starts.



# Look Who's Registered!

(as of November 11th, 2008)

WOW! We have almost 300 kids registered for 2009!

Effe Albitz, Niko Agnes, Gonzalo Arrangoiz, Pedro Arrangoiz, Olivia Bacon, Laura Baker, Chantelle Bannister, Joshua Bannister, Zachary Barton, Emily Beh, Lauren Beh, Megan Beh, Kevin Beltz, Kylie Beltz, Spencer Bemel, Gaston Benitez, Vince Biaggio, Mckenna Bolger, Grace Boyd, Madeline Boyd, Nicole Boyd, Daniel Burford, Andrew Bradley, Conor Brodnick, Elizabeth Brown, Ellis Brown, Evan Brown, Jessie Brown, Julia Brown, Marnie Brown, Dane Buchman, Jonathan Buchman, Sydney Carlson, Charlotte Carlton, Olivia Carlton, Claire Castaneda, John Cavanaugh, Matthew Cavanaugh, Michael Cavanaugh, Christine Chappelle, Kayla Christensen, Nick Christopherson, Peter Christopherson, Michelle Conway, John Combs, Rachel Conley, Anna Copman, Samuel Copman, Ben Crites, Ally Daily, John Daily, Jens Damgaard, Julia Danson, Sarah Danson, Stephen Davis, Gabriel De La Garza, Carter Downs, Walter Duff, Elizabeth Dwyer, Joe Dwyer, Connor Eastman, Jessica Eastman, Annie Epstein, Conor Failor, Jack Failor, Cosette Falker, Jordan Fallon, Allie Farino, Gabby Feltner, Gaby Feltner, Alec Felton, Melissa Ferrie, Joe FitzPatrick, Meggie Flinn, Sam Folkman, Danny Foussard, Sydney Foy, Erika Freiberg, John Freiberg, Helen Friberg, Maria Frogelius, Nicholas Gabanski, Rachel Gans, Andres Garcia, Daniel Garcia, Eugenio Garcia, Jorge Garcia, Adrian Garza, Alexander Gerrard, Grace Gerrard, Julia Goldman, Nicholas Goldman, Billy Grant, Michael Guckeen, Tyler Guckeen, Lucy Gworek, Vanna Gworek, Jonathan Hahn, Sarah Haley, Archie Hamel, Jack Hamel, Susie Hamman, Brittany Harrington, Paige, Harrington, Florence Harting, Hugo Harting, Anna Heinemann, Isabeau Hill, Mia Hill, Emily Hines, John Horan, Erik Horstman, Claire Howes, Cole Howes, Peter Hughes, Sarah Huss, Gracia Hutson, Harrison Hutter, Katherine Hutter, Audrey Imbs, Cole Imbs, Cameron Jackson, Patrick Jackson, Anders Jensen, Sarah Karels, Henry Kauth, Foster Kraft, William Krebsbach, Kevin Kruemplestaedter, Sara Kruemplestaedter, Courtney Kronschnabel, Nick Kronschnabel, Tory Kronschnabel, Kate Kugler, Taylor Kugler, Nick Lavezzorio, Will Lavezzorio, Claudia Leon de la Vega, Courtney Lilly, Miranda Lockner, Madeleine Loosbrock, Madeline Lorentzen, Olivia Lovrien, Sydney Lovrien, Ellie Mahoney, TJ Mahoney, Jose Maiz, Joe Mays, Schae Mays, Lilly McCarty, Zachary McCormick, Tessa McKerr, Lucas McGrann, Nolan McGrann, Emily McGuire, Katie McGuire, Megan McGuire, Molly McGuire, Lucy Melbinger, William Merriam, Matthew Meshbesh, Carlonie Michalek, Hannah Michalek, Kevin Mickan, Kevin Moakley, Sean Moakley, Hannah Moen, Caroline Moore, Robert Moore, Roman Moore, Chase Mueller, Jack Munkeby, Joe Munkeby, Mae Munkeby, Sam Munkeby, Aalee Newsome, Marjorie Newsome, Alexanara Niebur, Sioane Nilsen, Braze Nolin, Quinn Nolin, Ben O'Malley, Chris O'Malley, Evan Oncay, Grant Oncay, Andres Ornelas, Rodrigo Ornelas, Diego Orta, Juan Pablo Orta, Lars Oslund, Annie Padgitt, Nick Padgitt, Helen Palmer, Evan Patchen, Kaeli Patchen, Michelle Pazin, Brandon Pearson, Riley Peterson, Zander Peterson, Jeff Pflanz, Parker Poche, Juliet Prine, Lily Prine, Eliot Pulling, Lucas Rapetti, Riccardo Rapetti, Joey Rauenhorst, Jonny Rauenhorst, Jessica Reinhart, Christopher Revord, Claire Revord, Jack Revord, Kathryn Revord, Michael Revord, Alejandra Rios, Patricia Rios, Samuel Rosenberg, Michael Rutzick, Emma Ryan, Karli Ryan, Mauricio Saenz, Emma Schaffer, Ellie Scheid, Charlie Scheitlin, Megan Schmidt, Caroline Schuler, Mary Grace Schuler, Emily Sciortino, Mary Claire Seeberg, Jack Selzler, Max Seymour, Bryn Shank, Katie Shaughnessy, Mary Shaughnessy, Andrew Shumway, Olivia Sieff, Danielle Sikora, Alyson Sklare, Cole Spencer, Eden Spencer, Tate Spencer, Hannah Stevens, Parker Stevens, John Stone, Thomas Stone, Daniel Suchsland, James Sweeney, Jack Taylor, Liesl Thome, Jack Thompson, Bridget Thomson, Spencer Tinsman, Alex Tyler, Maddie Vill, Alejandra Villarreal, Eugenio Villarreal, Gregory Vogel, Johnny Vogel, Hedvig Von Essen, Oscar Von Essen, Luke Walden, Julia Wallace, Peter Wallace, Jack Walsh, Jack Welch, Steven Westra, CJ Whitaker, Drew Whitaker, Alex Williamson, Kendall Williamson, Katie Winslow, Cami Zecker, Alex Zwaschka

## Look Who's Working in 2009!

Not only have our campers been busy registering but many of our staff have re-applied for 2009!

Although we have had LOTS of interest, the following staff are pretty much locked in already for 2009: **Tracey Chuckas, Annie Ormiston, Sara Brueggeman, Jen Gray, Lo Wood, Laura Cadamagnani, Wes Long, Carrie Stageman, Aaron Nelson and Andy Hearet.**

There is still time to bug your favorite counselors to see if you can get them back to camp!

## NEW Assistant Directors!

We are excited to have **Sean Gokey, Chris Mathiowetz and Jenny Delaney** join the year-round Foley team in January! It will be great to have more faces around the office throughout the winter and we look forward to working with them for the upcoming year!





BULK RATE  
U.S. POSTAGE  
PAID  
PINE RIVER MN  
PERMIT NO. 72



9303 Father Foley Drive, Pine River, MN 56474

To:

*Address Service Requested*

[www.campfoley.com](http://www.campfoley.com) • [fun@campfoley.com](mailto:fun@campfoley.com) • 218-543-6161

## Tell Your Friends About Foley!

Do you know someone looking for fun, friendships and new skills? Share with them your memorable experiences of Camp Foley and encourage them to register. You'll receive \$25 off your camp tuition for each person you sign-up. So... tell your friends! Applies only to registrants who are totally new to Foley, excluding siblings or children of alumni.

**Send Information Immediately To:**

Last Name \_\_\_\_\_ Home Phone (\_\_\_\_\_) \_\_\_\_\_

Parent's Name \_\_\_\_\_ Email Address \_\_\_\_\_

Address \_\_\_\_\_

Children's Names \_\_\_\_\_ Age/Grade \_\_\_\_\_

\_\_\_\_\_

Referred by \_\_\_\_\_





December 2008

Make your summer **SIZZLE!**

*Warmest Wishes!*

The Foley Crew would like to wish each and every one of you a very **Happy Holiday Season** and a **Wonderful New Year!**

We hope that 2009 will bring **contentment, hope and happiness.** Thank you for all your support of Foley and we look forward to hearing from you in 2009!

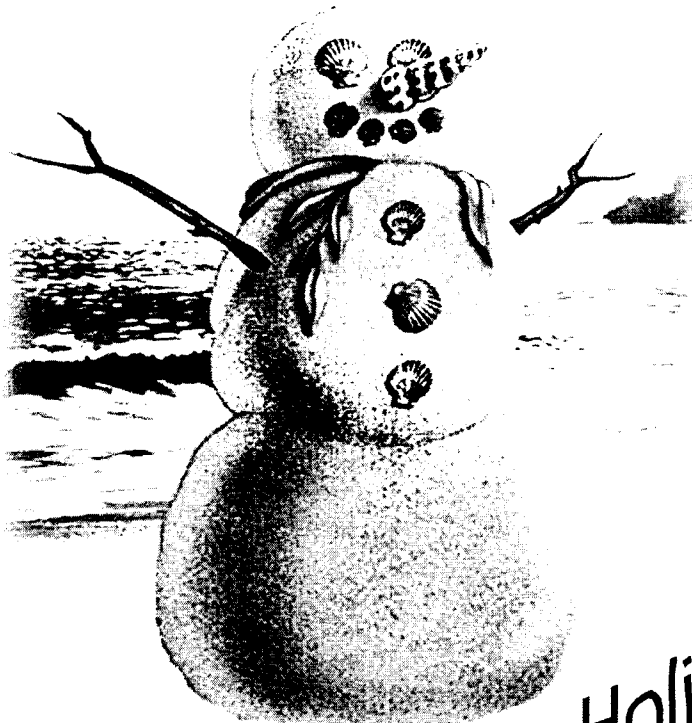

*Happy Holidays!*

*Alli Marie*

# 2008 Honors

## Silver Paddle Award

Created in 1969, the Silver Paddle is the highest honor a camper aged twelve and younger can achieve at Foley. Not only must you receive awards in a variety of camp activities but you also must be a person of good character and a role model for the other campers.

We would like to congratulate **Jack Hamel** on receiving his Silver Paddle this past summer. Jack is only the 42nd camper to receive the Silver Paddle and it is a big accomplishment! Well done, Jack!



## Birchbark Awards

The Birchbark Awards are awarded to campers who complete at least half of the requirements for the Silver or Gold Paddle. The Paddle Awards are for those campers that have achieved a rounded development in the various activities offered at camp and who have followed Foley's Code of Living. For 2008, we would like to recognize **Isabella Loosbrock** for putting forth the effort to complete the requirements for the Silver Birchbark Award. Hats off to **Antonio Camiro** for his diligence in earning his Gold Birchbark Award! Congrats!



Isabella Loosbrock



Antonio Camiro

## Anchor Awards

The Anchor Award is an award that honors outstanding campers who demonstrate qualities of being friendly, well mannered, respectful, and enthusiastic. All nominees for the award must have attended camp for a minimum of 5 weeks. The recipients are chosen by written vote of both the campers and staff during each session. The 2008 Anchor Awards were presented to the following campers:



1st Session  
Sarah Gibbs & Casey Hudak

2nd Session  
Kylie Beltz & Patrick Gibbs



3rd Session  
Rosie McCarty & Erik Mueller

4th Session  
Emilia Kronschnabel & Matt Kronschnabel



## Hall of Fame

Besides our traditional activity awards and Anchor awards that were distributed to deserving campers, The Hall of Fame is another important achievement. To obtain this recognition, a person needs to spend 10 summers at Foley as a camper and/or counselor or combination of the two.

**Bridget Moffet** celebrated her 10th year at Foley this summer and was inducted in to the Camp Foley Hall of Fame! Bridget is a second generation camper who first came to Foley as a 5 year old back in 1999.

Although she doesn't remember much of those early days, she remembers having an "awesome" time. In 2001, her highlight was the Harry Potter Banquet and winning the costume contest. Starting in 2002 she met many of the girls that she is still coming back to camp to see and the same group has "grown up" together in a cabin ever since. It has been great having Bridget in camp and we all agree that she embodies the Foley spirit!





# Bridge Crossing Essays

(Excerpts from the 2008 Bridge Crossing Essays)

The qualifications needed for the Bridge Crossing are attendance at Foley for at least 5 years and completion of the "What Camp Foley Means to Me" essay. There were many campers who were eligible for this honor, and we would like to thank the 10 campers who decided to take the time to put their Foley experience into words by completing the essay. Congratulations!

Gracia Hutson



I think that I'd be a different person without camp. Every year I seem to lose myself but when I come here I remember who I am. Every year I've been here I've met great role models and learned many lessons.

Stephen Davis



I believe the heart of Camp Foley is freedom, imagination, and equality...The final part of camp is equality. Let's be honest, how many of us are treated better here than at school by other kids? I know I sure am! Everyone is equal here at camp.

Matt Kronschnabel



...Camp can make the most timid of people into confident, outgoing leaders. The atmosphere that camp provides allows people to be themselves, voice their opinion, and share ideas without prejudice.

Emily Newman



The first thing that I love about camp is the people. Whenever I have been down or homesick all I would have to do is look beside me and I would see a smiling face ready to listen and help me out. The counselors and directors are pretty much super fantabulous. NEVER have they let me down.



Mia Fernstrom

I have come all the way from Japan every year since I was seven. Which is so worth it. And I have the time of my life here at Camp Foley. Every year I come back to camp and always, ALWAYS think home sweet home.



Brady Duncan

The thought of Camp Foley keeps me motivated throughout the year to do well in school and stay out of trouble.



Will Burke

Camp is the only place I know that has such a high power to bring such a diverse group of people together. Camp has changed and influenced me so much to the person I am today.



Aly Sklare

The laughing at camp is a constant. That's one of the things I think of when I think of Foley, laughter. Everyday there is something to laugh about. Even when I tell stories from years past, from stupid things I have done to the funny things, we all remember and it brings laughter and smiles to our faces.



Archie Hamel

There is a feeling there that is unmatched by any other feeling in the world even if it was a small accomplishment it still feels great and the best part is the people around you congratulating you for your great accomplishment. This feeling is unmatched, unequal and the most uplifting. And there is always a higher and more difficult goal to shoot for so you can always push yourself.



# Camp Foley Online!

## Alumni Page!

Yes we know it needs work! That is why we are going to be revamping the Alumni portion of the website in order to allow you all to reconnect with past cabinmates and counselors. **Look for the new and improved Alumni portion in early February.** Also, we want your input! What do you want to see on the website? Call or email us ([fun@campfoley.com](mailto:fun@campfoley.com)) and we will try to incorporate your ideas!

## Foley on Facebook!

We have been using facebook for years with our camper and staff population but in the last six months or so we are getting a HUGE response from Alumni that are using facebook. Not only is facebook an excellent way for you to keep connected (or get reconnected) with other Foleyites, but it is also a GREAT way for you to help us spread the word about Foley!

There are a couple ways that you can stay connected via facebook:



Become a Foley Fan - add Camp Foley to your list of Fan Pages on your profile. The easiest way to do this is search

for "Camp Foley" in facebook. Then click on "Pages". You can then select Camp Foley. You can also go to this direct link: <http://www.new.facebook.com/pages/Pine-River-MN/Camp-Foley/34721577295>. Leave us a review and also find out about events that we are having.

Welcome to:



Join the Camp Foley Alums group - Use this web address to find the "Camp Foley Alums" facebook group: <http://www.new.facebook.com/group.php?gid=8206283669>.

NEW in December are pictures from the 70's, 80's and 90's! We will continue to add pictures as we convert them to digital.

## Newsletters!

We will have all our newsletters up on the website for you to check out! This is a great way to find out what is going on at Foley and learn all about the next generation of Foley campers and staff. We have Newsletters that go out to our campers about once a month throughout the winter months.

## Scholarship Donations!

The Scholarship Donation Form will also be available online for your convenience. We are working with the American Camp Association to see if there is a way for you to make online contributions. Thank you for your consideration in donating to this valuable fund!



## Foley's Podcast - "The Gong"!

Many of you have already gotten hooked on "The Gong" - Foley's Podcast! If you have yet to discover the magic - you should! Each month a new one will be posted! Catch up with **news** from around camp, hear funny skits and songs and relive some of those famous Foley memories. We also do interviews and allow you to give input on what is on the next episode.

Want to learn more?? Check out the Foley website and click on the "Podcast" link. You can subscribe (don't worry - it's FREE) to "The Gong" also! This ensures you don't miss an episode!

We want your input as much as possible! **Email, call, facebook, or write us a letter to give us updates on what you are up to throughout the winter so we can add you to the next broadcast!** We will also be adding an Alumni portion to the Podcasts so give us your updates!





# Frequently Asked Alumni Questions!

Every year we spend time answering some of the same questions over and over for our Alumni. Although much of camp has remained the same, some things have had to change as the expectations of our campers and staff change. Here are some of the most frequently asked questions and their answers.

**Are the cabin names the same?** Yes! The boys are sleeping in the East end of camp going from youngest to oldest in Mandan, Kewaskum, Kadigomeg, Shingwako, Kildare, Seneca, Ojibway, Mingo and Wahtassa. The girls sleep on the West end starting in Yakama, Ishtakaba, Micmac, Sacajawea (part of Micmac, used to be Micmac II), Menominee (originally named Moorman and housed support staff), Pocahontas and Matoaka (originally the Wilderness Post where trips were packed out), Hiawatha and Tekawitha (originally where the Catholic Sisters lived when cooking for camp. Hiawatha used to be Tek II.)

**Do you still tell the story of Big Red?** No! Times have changed and we no longer tell scary stories.

**Do you still have campers from Mexico?** Yes! In 2008 we had 55 campers from Mexico; 3 from Italy, 6 from Sweden, 4 from Japan, 4 from France, 2 from United Arab Emirates, and 1 from England. We generally also have two or three international staff.

**Do you still have all camp campfires?** Yes! We have an Opening Campfire filled with stories, songs and skits and the Closing Campfire or Awards Campfire. Counselors are still using their imaginations to create lasting memories. We also have a Friendship Campfire that has been a tradition since the 70s.

**Do you still send cabin groups out on the Voyageur (houseboat) or to the Tipi?** No! For a different twist we have 2 sets of tree houses where campers spend the night with their cabin mates.



2008 Treehouses

**Do you still eat soda bread on Sunday morning?** Yes! We are still making those delicious butter-milk pancakes from scratch too.

**Do you still play Reveille every morning to wake up the campers?** No! When an electrical storm took out the PA system in the late 80s we did not replace it and returned to creating a more peaceful environment without 15 or so "bugles" going off throughout the day. Counselors use their creativity in waking the campers up every day and the campers manage to get to their activities.

**Does the bell still ring for meals?** Yes!

**Is there still Saturday night boxing?** No! There is a climbing tower where the boxing ring was originally located.

**Do the campers still get to choose their activities?** Yes! The number of activities has expanded! Check out [www.campfoley.com](http://www.campfoley.com) to see all of the choices.

**Do you still put a red ribbon around the neck of campers who cannot swim?** No! Campers and staff now have to wear lifejackets when they are in boats so the need to know who can swim way out in the middle of the lake is less necessary. Kids are still tested on their swimming and take swimming lessons if they do not pass the swim check.



1970's Boating



# 85 Years and Counting!

In 1924 **Father Foley** had a dream of creating a place where boys could come to work, play and learn independence. Now, **85 years later**, Foley is still committed to allowing children (we added girls in 1974) those opportunities. In honor of our 85th anniversary, we have several exciting events going on at camp. We invite all of our alumni to be part of the festivities!

## Time Capsule

Back in the 80's we buried a time capsule that will be opened in 2024 (at the 100 year anniversary). Our campers have been bugging us to bury an additional capsule so that their memories can be preserved for a shorter time frame. This summer we are going to bury a capsule that will be opened, along with our original one, on the 100th anniversary.

We are asking our Alumni to help us add to that project! Sometime before August 8th, 2009 if you would like to add something you can either mail it to us or drop it off at Foley! You can also write about a memory, what Foley has meant to you, or what you gained from the experience.

Email responses to [fun@campfoley.com](mailto:fun@campfoley.com) or mail them to the camp office. We will make sure they are printed on Acid Free paper for preservation underground. Help us pass on the Foley spirit to the next generation!



## Commemorative Gear

We will have special 85th anniversary stuff for sale through our camp store this year! We haven't made a decision on whether we are going to do clothing or other items, but please check the website for more information in February.

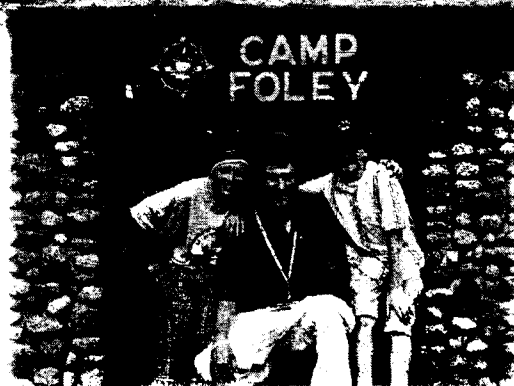

## Tour & Lunch

We would like to invite you all to join us at Foley for one of those wonderful camp meals and to tour camp! Bring along spouses, children, grandchildren, family or friends to see the place that has so many great memories for you!

To help us make sure we have tour guides ready to go and a spot for you to sit in the dining hall, please give us a call prior to your trip to Foley!

We are constantly adding new things and updating our facilities so even if it has only been a few years for you, there is always something new to see!

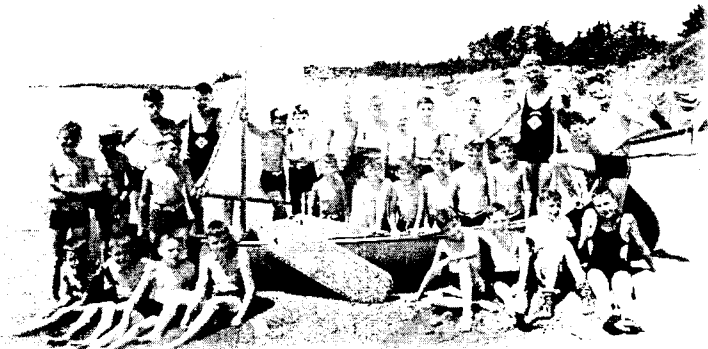

# 2008 Scholarship Donors

Camp Foley would like to extend a big THANK YOU to everyone who supports this program through contributions. Although our 2008 Scholarship Donations, totaling \$6614.94, fell short of our goal of \$8000.00, we were still able to offer full and partial scholarships to 14 deserving applicants, giving them the opportunity to experience all that Camp Foley has to offer. Our scholarship campers add diversity to our camp community, generally coming from inner city and rural settings. Some of them are wards of the state, being raised by a grandparent, from low income families struggling to make ends meet, or from needy families seeking opportunities to provide their kids with positive alternatives to inner city gangs, drugs, rural isolation and/or other challenges. Please help us continue to offer this great service to these kids!

## Here is what a few of the scholarship kids had to say about their 2008 Camp Foley experience:

"Thank you for letting me return to Camp Foley. I've been attending Foley for 5 years and each year, it gets better. My main activities have been paintball, riflery and trap. All of these have increased my concentration and bravery. If I had never started attending Camp Foley, I don't know what kind of person I would be. Camp taught me to be more tolerant of different people and it helped me become more social and have more confidence when I talk to people... Once again, I thank you!" Boy age 14

"I had a great time at camp and I really miss you guys. I wanted to thank you for making my summer awesome. The activities that I was involved in were so fun. It really hurt to leave but I know that I was going to see family. You helped me through the homesickness. Alli, you were also like my best grown-up buddy. I had a great time this summer and I really appreciate all that everyone has done for me." Girl age 11

"Thank you for giving me the opportunity to attend Camp Foley. I enjoyed myself and I am looking forward to another year filled with fun and excitement... Before I attended camp, I never knew how to rock climb or fish... Being on my own and having to keep up with my things made me realize that I had to be very responsible. I couldn't rely on my parents anymore; I had to rely on myself... Thank you for turning my summer into a summer opportunity of a lifetime and getting me prepared for middle school." Girl age 11

"Thank you for accepting me into the Camp Foley Family. I have been there two years and each year was different. I am usually with the same people every day, but at camp I met people from around the world. Camp Foley gave me a sense of the beauty of nature and the outdoors. At camp, I have become more responsible and more organized. I loved my time at camp. Thank you for the opportunity to experience such a wonderful and memorable place. My time at Camp Foley was not just a summer opportunity of a lifetime, but a life changing experience! Girl age 11

## Want to make a donation???

Please send your tax deductible donation to Camp Foley. Checks should be made to the "American Camping Association" and designated for the Camp Foley Scholarship Program.

## Direct Scholarship Donors (\$6285.00)

Joseph and Kathleen Blanke  
 Tom Braig  
 Julia Brown  
 Taylor Costas  
 Mary Durkee Galbraith  
 Michael Goldberg  
 Greg Haley  
 Cynthia Harris in memory of her daughter Jennifer  
 Peter and Kym Kronschnabel  
 Richard and Kim Merriam  
 Kathleen Philipp  
 Gerald Reichert in memory of H.L. Reichert, M.D  
 Kathy and John Sluis in honor of camper Michael Sluis  
 Geoffrey Steger  
 John and Lois Welshons- in memory of Jane Williams  
 Terry and Mary Westra  
 Haven and Linda Williams

## Family Donations via Summer 2008 Canteen Balances/Other (\$ 329.94)

Tom and Michelle Bradley	David and Sharon Jaeger
Jim and Lisa Carlton	Michael and Kimberly McCormick
DeBorah Crawford	Carlos and Jan Mickan
Robert Dwyer and Walter Pophin	Kristin Peter
James and Kristi Eiler	Chris and Ann Pulling
Michael and Molly Hannigan	Kristin Rotter
Rick and Kate Hartfiel	Andrew and Vibeke Sansone
Nancy Holt	John and Lisa Shaughnessy
Dave and Michelle Horan	Dean and Lisa Stinchfield
Rob and Alicia Hutter	Kent and Molly Wangsness



9303 Father Foley Drive, Pine River, MN 56474



BULK RATE  
U.S. POSTAGE  
PAID  
PINE RIVER MN  
PERMIT NO. 72

To:

*Address Service Requested*

www.campfoley.com • fun@campfoley.com • 218-543-6161

## Tell Your Friends About Foley!

Do you know someone looking for fun, friendships and new skills? Share with them your memorable experiences of Camp Foley and encourage them to register. You'll receive \$25 off your camp tuition for each person you sign-up. So... tell your friends! Applies only to registrants who are totally new to Foley, excluding siblings or children of alumni.

**Send Information Immediately To:**

Last Name \_\_\_\_\_ Home Phone (\_\_\_\_\_) \_\_\_\_\_

Parent's Name \_\_\_\_\_ Email Address \_\_\_\_\_

Address \_\_\_\_\_

Children's Names \_\_\_\_\_ Age/Grade \_\_\_\_\_

\_\_\_\_\_

\_\_\_\_\_

Referred by \_\_\_\_\_

